

AT 200

Flexibility and productivity
in con rod machining.

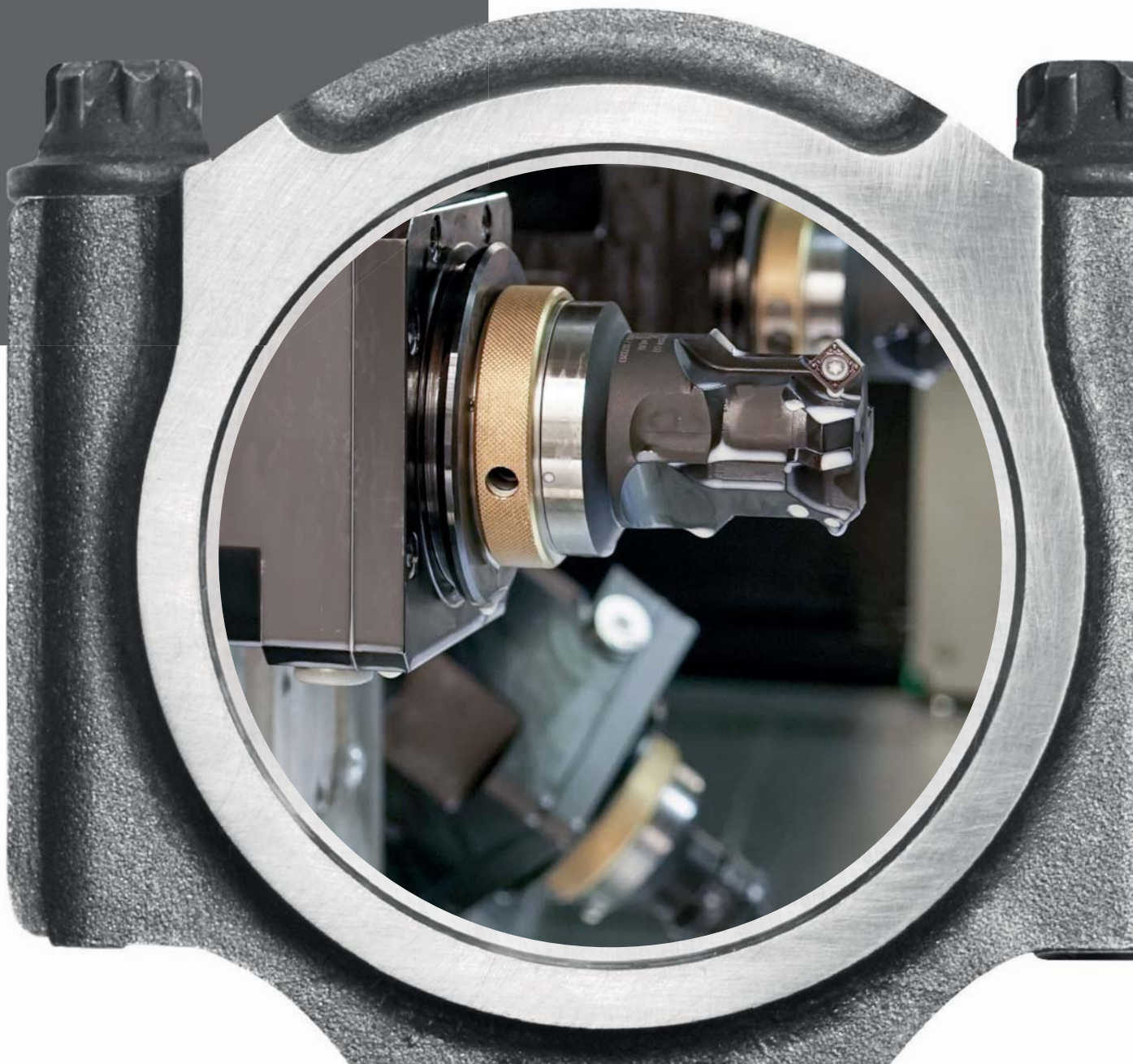

AT 200

**Minimum non-productive times.
Maximum production.**

Professional division of work tasks: The division of semi-finish machining and finish machining in the highly specialized machines AT 200 respective AF 400 allows the parallel machining of components. The fixtures can be optimized for the different requirements of semi-finish and finish machining, thus enabling a drastic increase of productivity and precision. In addition, this separation of machining operations provides for a simpler and clearer process sequences.

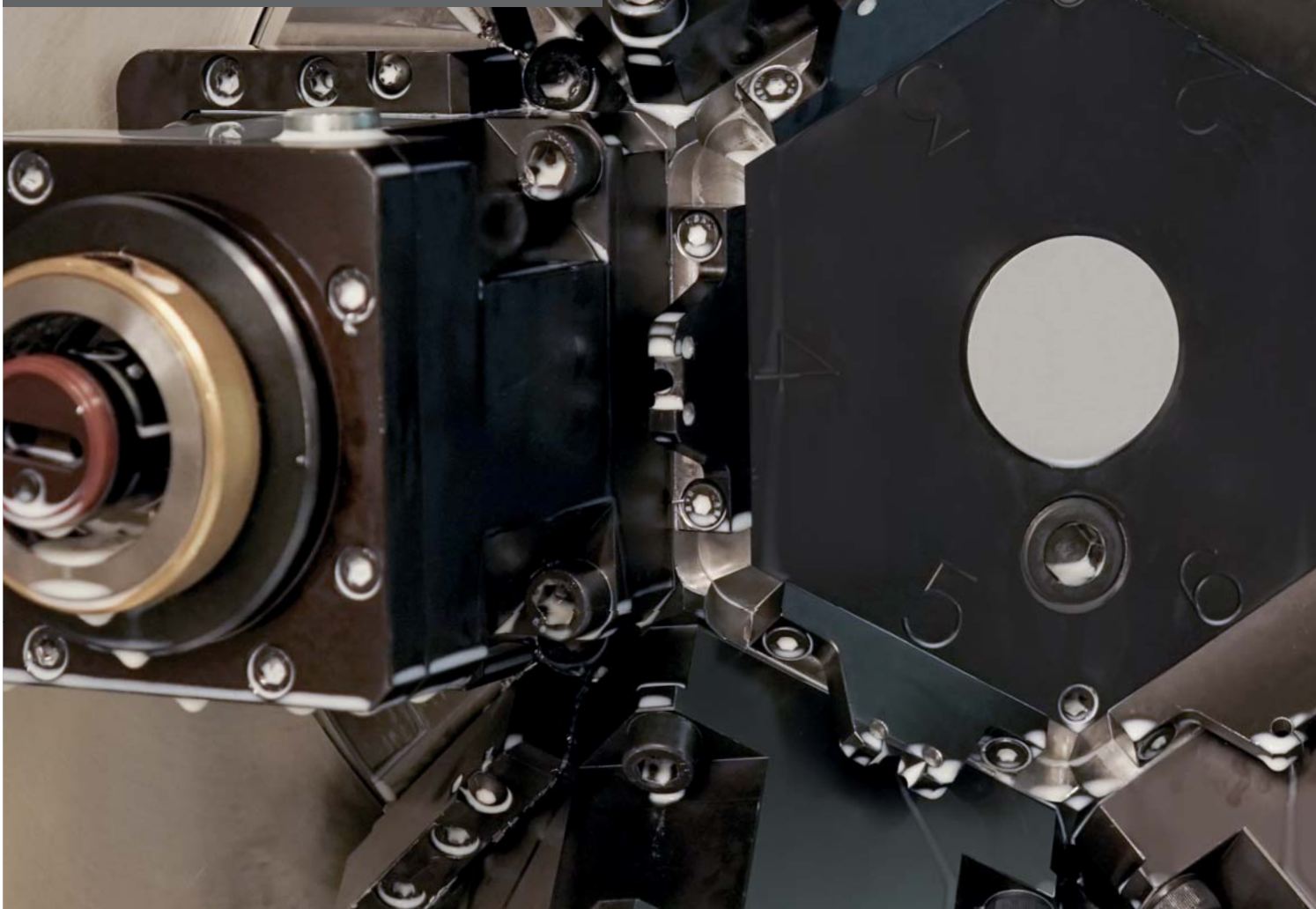

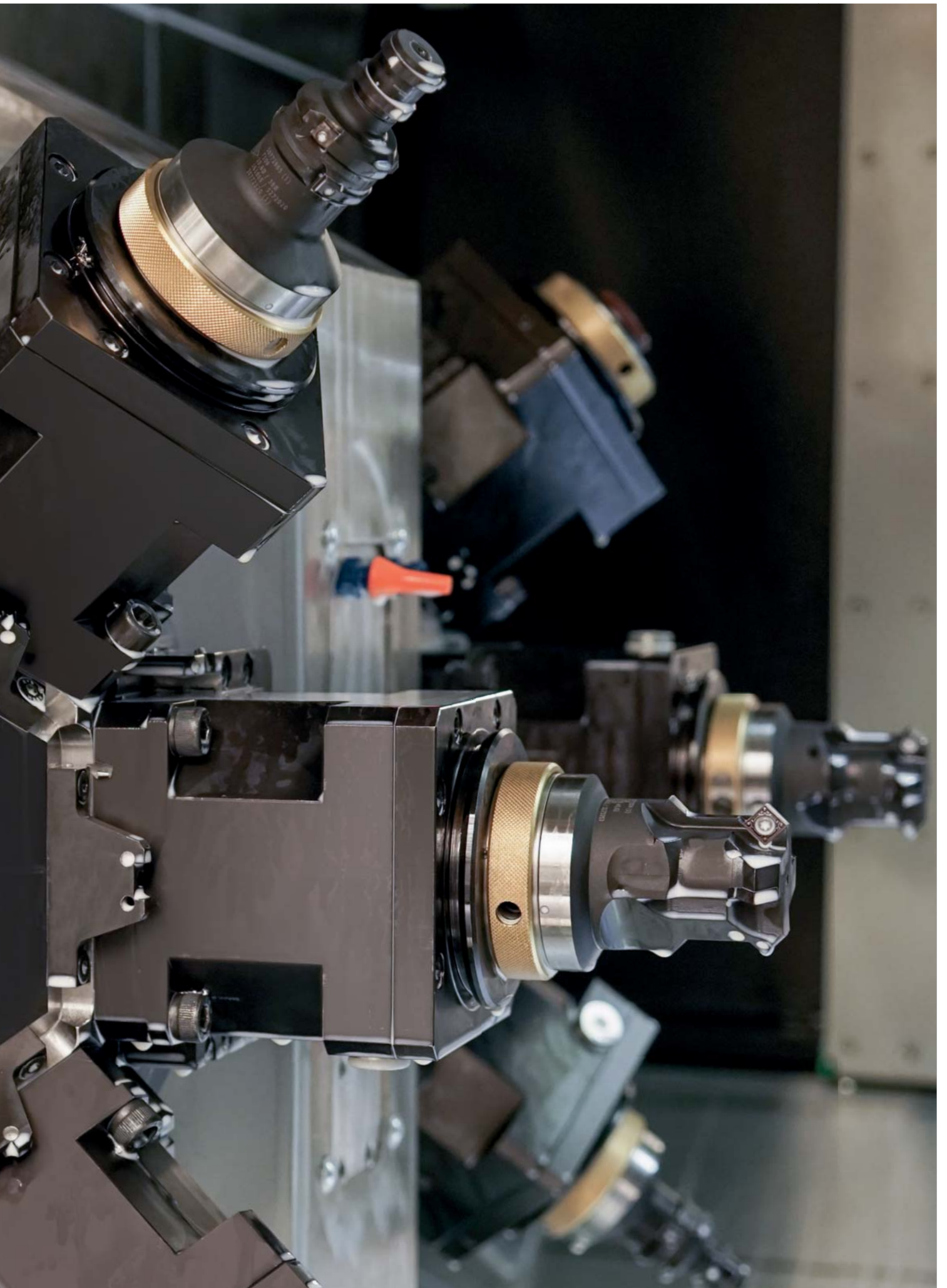



To be un

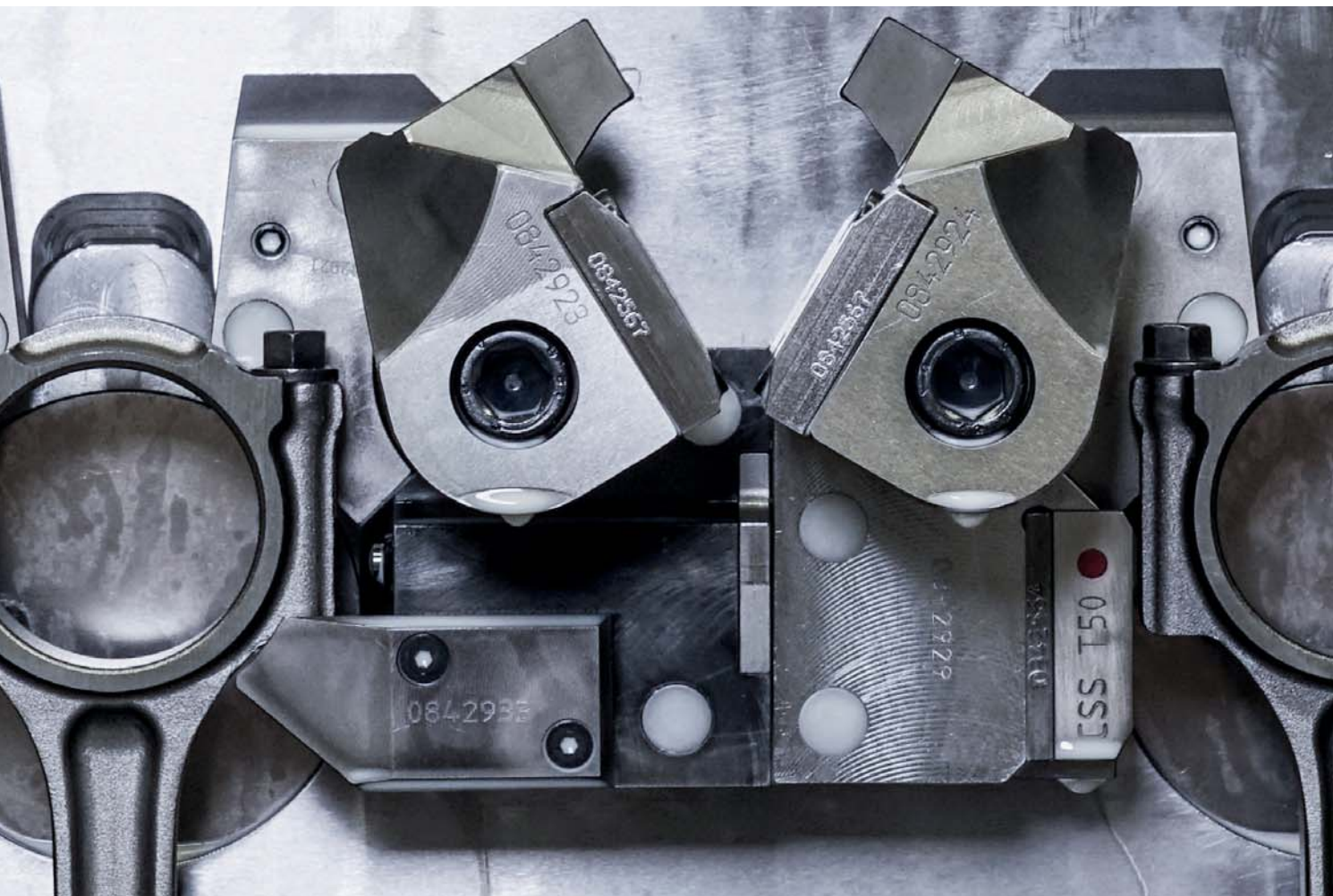

compromising

means to create a customer-oriented concept leaving the limits of existing technologies behind. As a result, this uncompromising attitude is the foundation of a new, highly specialized and modular generation of con rod machines.

High production volume. Consequent flexibility. Individual scalability. Low change-over times. Highest precision.

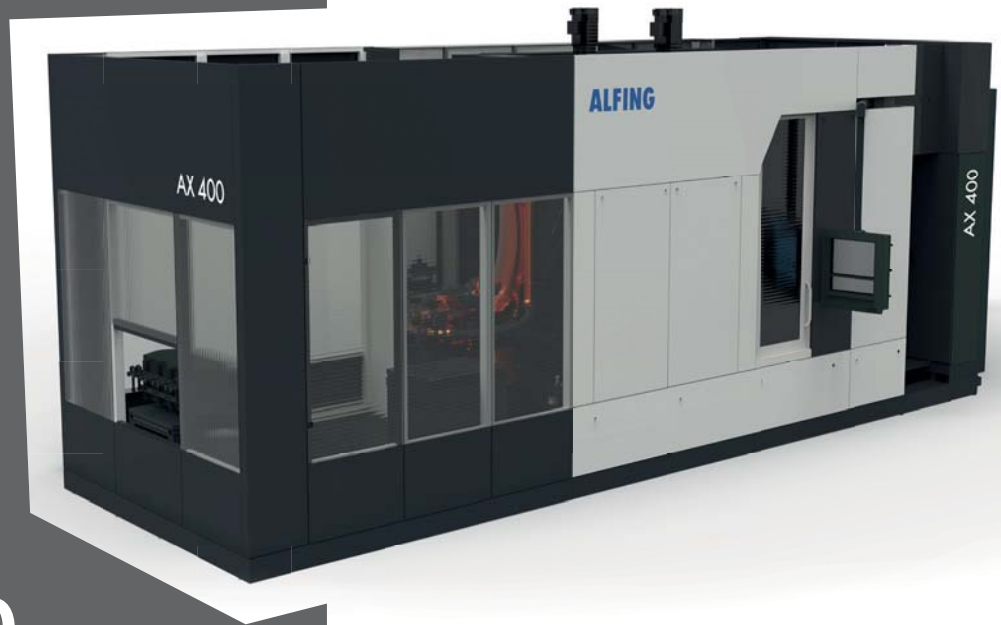

AX 400

The AX 400 for rough machining of con rods.

- Productive as a special purpose machine, flexible as a machining center.
- Machining of up to 4 con rods simultaneously
- Extremely short chip-to-chip time thanks to main time-parallel tool change
- Main time-parallel loading and unloading of components
- Loading robot integrated in machine control, thereby simple operation without any robot knowledge
- Ergonomic loading station for quick and fool-proof tool change, no access into working area required
- Flexible due to integrated tool magazine
- Quick change-over possibility: fixture change by robot, tool change by loading station



ROUGH MACHINING

- *Rough bore crank and pin end*
- *Machining of bolt seat, bolt holes and thread*
- *Finish machining pin end for bush insertion*

ROTARY INDEX TABLE ASSEMBLY MACHINE



The rotary index table assembly machine for fracture splitting and assembly of con rods.

- Cycle times < 9 seconds, even with single-track concept
- Use of latest laser technology
- Worldwide first machine for fracture splitting of con rods made of highly ductile materials: use of cooling by nitrogen
- Highly efficient nut runner technology
- Position-oriented bush assembly
- Integration of further operations such as measuring, calibrating and outbreak control
- Recording and evaluation of all important parameters
- High operator convenience



FRACTURE SPLITTING AND ASSEMBLY

- Laser scribing
- Fracture splitting
- Torquing
- Bush insertion



AT 200

The AT 200 for semi-finish machining of con rods.

- Up to 4 fixtures can be mounted simultaneously for short change-over times
- Up to 2 turret heads with each 4, 6 or 8 tools
- Extremely short chip-to-chip time
- No chip problems at the tool interface thanks to the use of the tool turret
- High thermal stability
- High operator convenience
- Very good accessibility for maintenance and tool change
- Low space requirement in floor space and height
- Very versatile: as variant with Y-stroke 630 mm a highly productive and process-safe alternative compared to a machining center



SEMI-FINISH MACHINING

- *Semi-finish bore crank end*
- *Tee-pee machining*
- *Drill oil hole*
- *Mill lock notch*
- *Face milling*

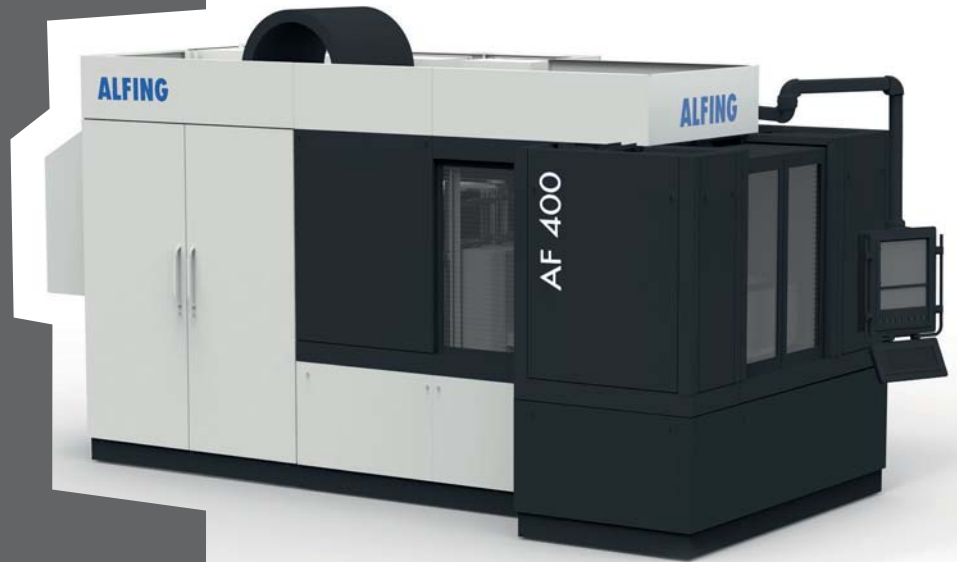

AF 400

The AF 400 machine for finish machining of con rods.

- Highest precision due to optimized servo axis arrangement
- No protruding masses thanks to compact axis arrangement
- Oval and trumpet form bores with freely programmable geometry
- Simple, scalable production increase
- Hydrostatic spindles with highest precision, stiffness and damping
- Optional with more cost-efficient spindles with roller bearings
- Up to 4 fixtures can be mounted simultaneously for short change-over times
- Directly driven, NC-programmable main spindles
- High thermal stability
- High ease of operation
- Very good accessibility for maintenance and tool change
- Low space requirement in floor space and height



FINISH MACHINING

- Fine bore crank and pin end
- NC-controlled form and oval boring
- Roller burnish pin end

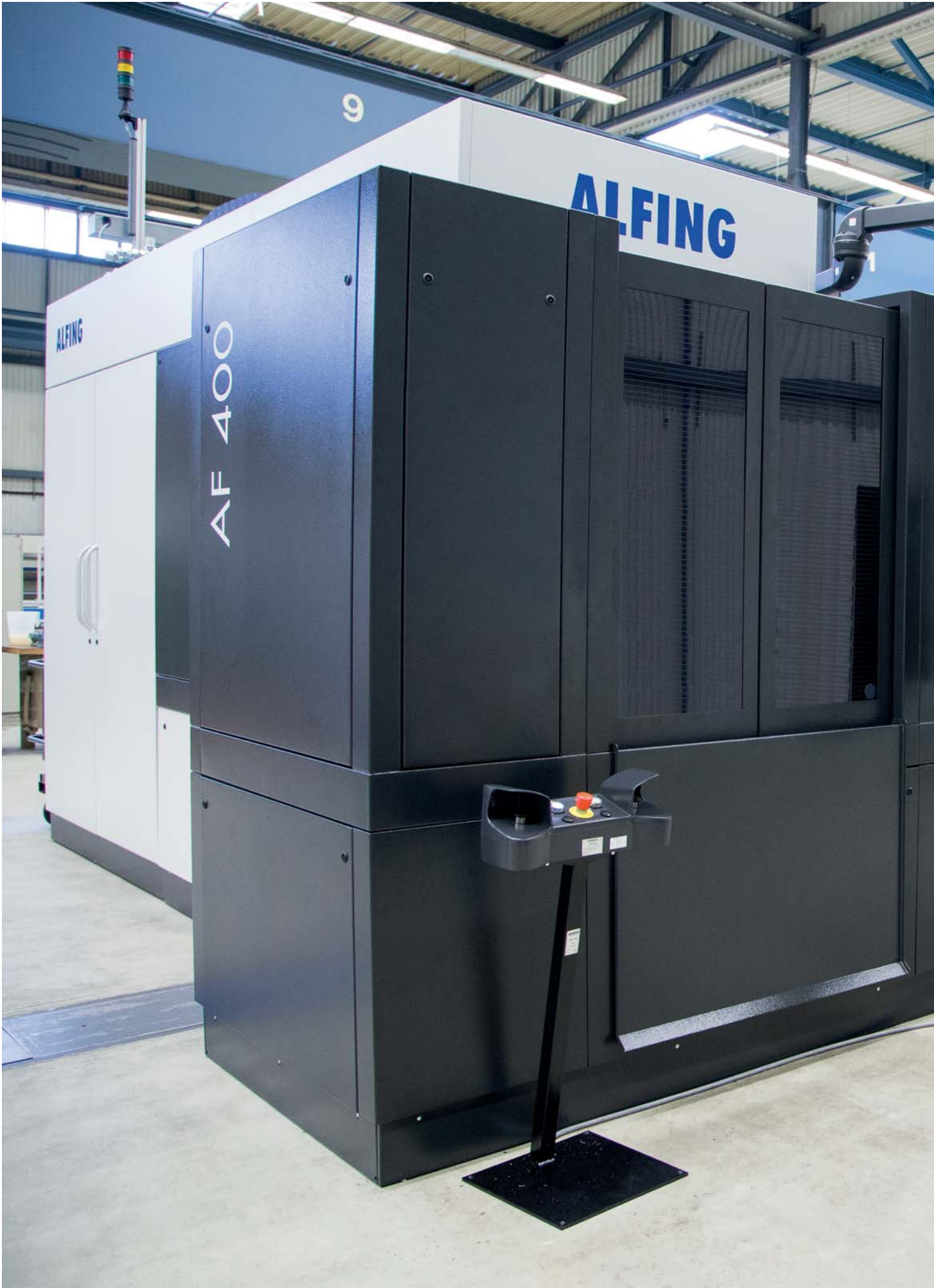



AT 200

Schematic representation of the machine and its basic components.

1

CLAMPING FIXTURE

The clamping fixture swiveling around the A-axis moves linearly in Y-direction.

2

TURRET BORING HEAD

Two turret boring heads can each receive 4, 6 or 8 tools.



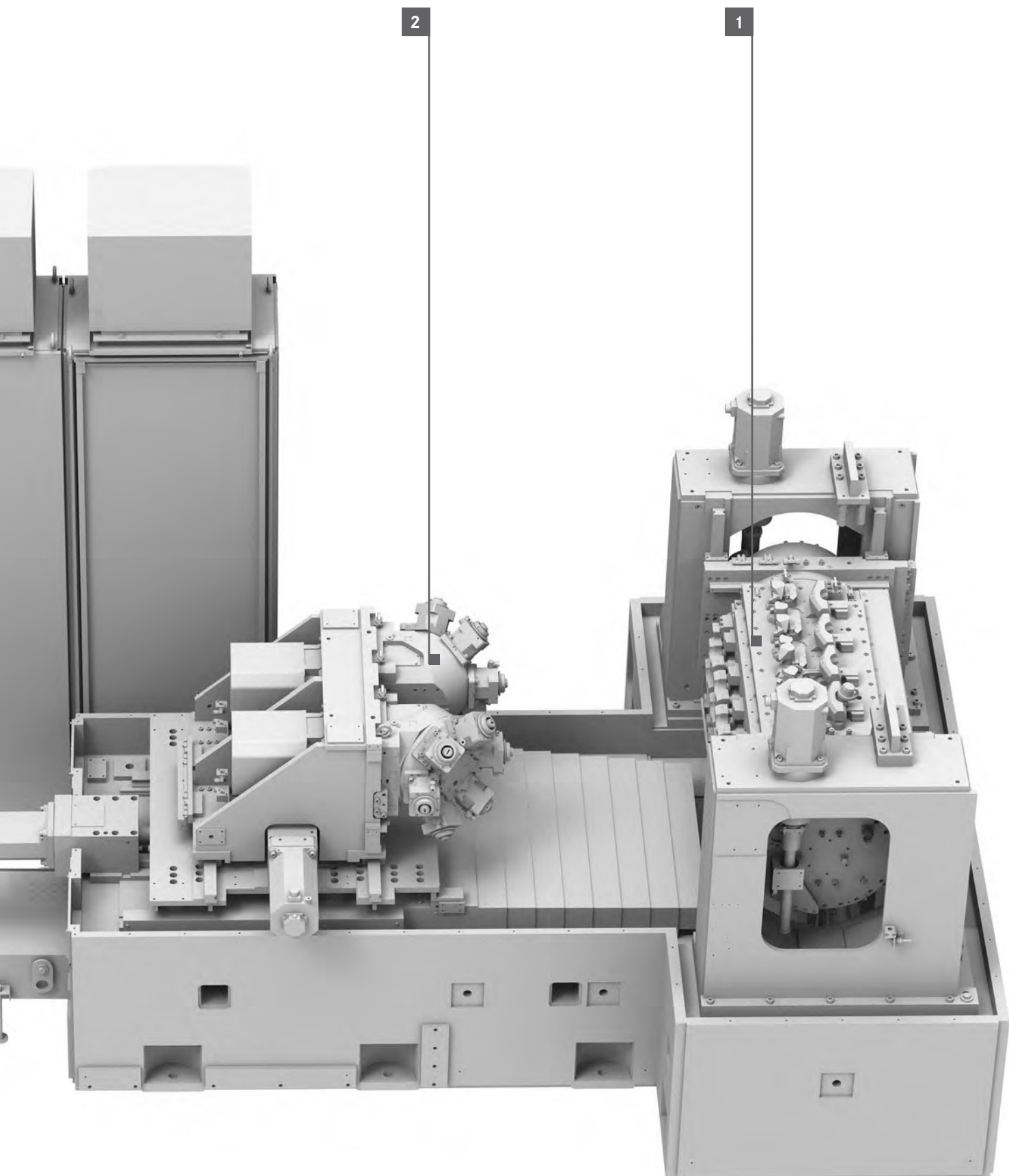

UNCOMPRO- MISINGLY SPECIALIZED

The AT 200 and the AF 400 con rod machines are specialized in semi-finish and finish machining whereby every machine is optimally designed for the corresponding requirements. Highly precise sub-assemblies are only used where required. The division of work tasks to two machines provides for easier and clearer process sequences.

PARALLEL MACHINING

In a machine concept combining finish and semi-finish machining, the corresponding work steps can not be realized simultaneously at different stations.

Therefore the ALFING solution allocates the machining process to two smaller, highly specialized machines with an overall higher productivity and precision.

SPINDLE EFFICIENCY

The stand alone semi-finish machining increases the efficiency of the fine boring spindles. As these are exclusively used for finish machining, highest precision is only used where it is required.

SUPERIOR MACHINE CONCEPT

The AT 200 is the product of intelligent and user-friendly development specifications. Among others, this means a particularly uncomplicated tool change due to improved accessibility, high flexibility in use and a scalability tailored to meet the market needs. In addition, the compact design allows for a flexible positioning in the floor layout, thus reducing the required floor space.



FINE BORING SPINDLES



CLAMPING FIXTURE

VERSATILITY

Thanks to the tool turret principle and the possibility to use up to 2 x 8 tools, the machine can be applied - apart from semi-finish machining - also for rough machining of con rods as well as for the machining of other components.

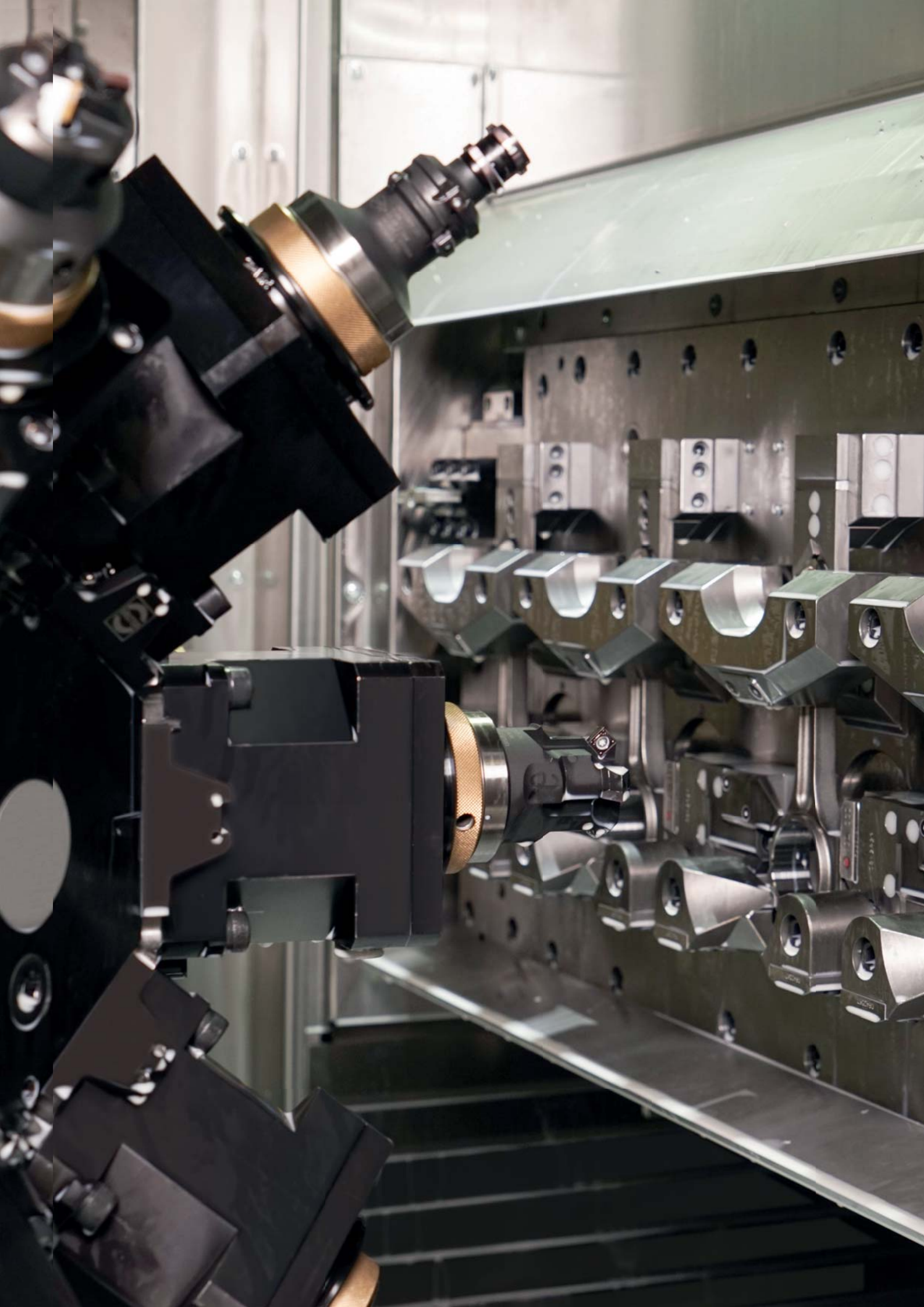

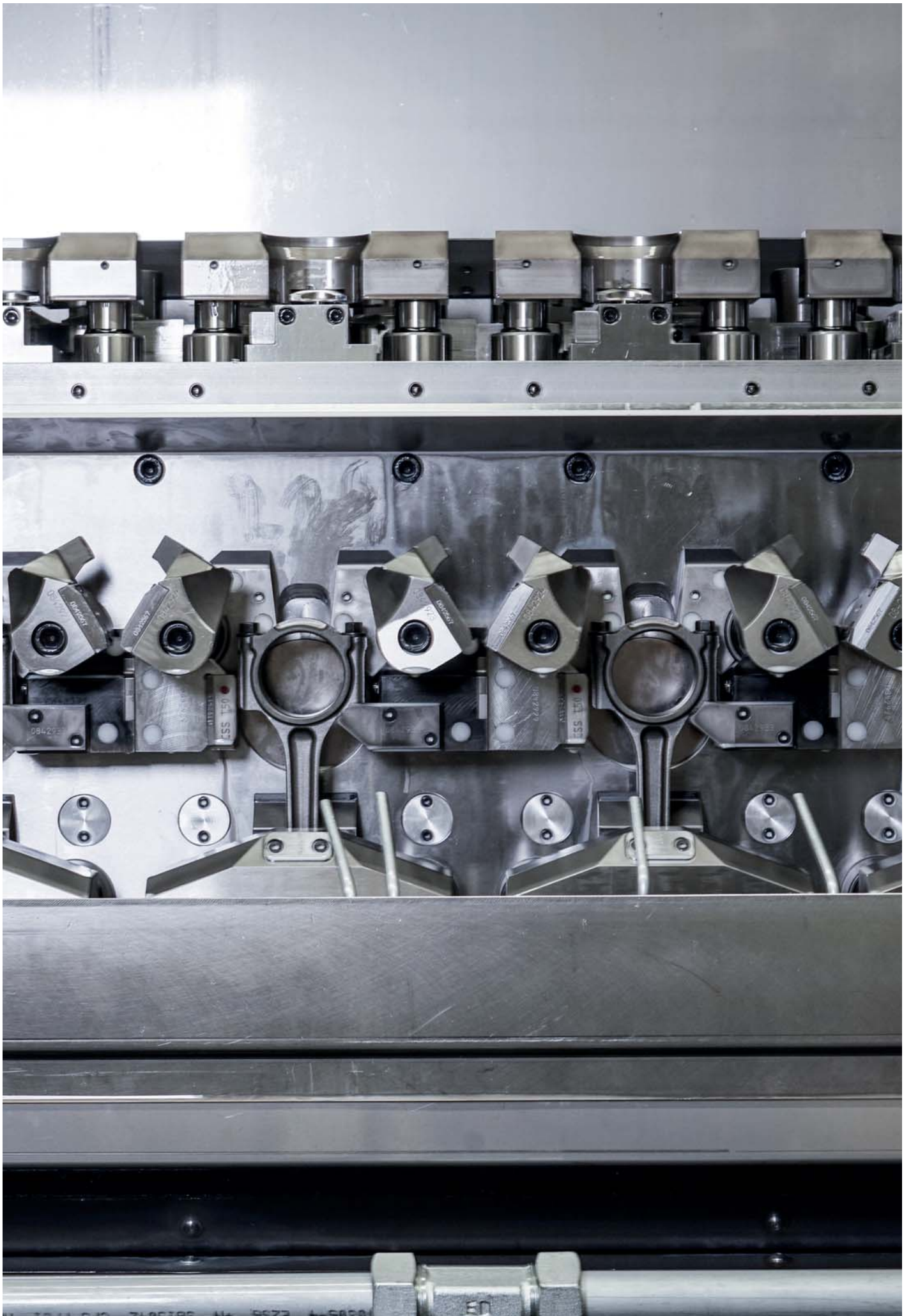

UNCOMPRO- MISINGLY FLEXIBLE

The clamping fixture swivels around the A-axis and can be moved linearly in Y-direction. It can be quickly changed over and allows a clamping sequence freely programmable in the NC program. Due to the high flexibility it offers the possibility to quickly, easily and cost-efficiently produce different component types on the machine. Thanks to the clamping tombstone concept, up to 4 different component types can be machined without any change-over.

HYDRAULIC ROTARY DISTRIBUTOR

The rotary distributor provides 11 possible connection points:

- 1 x lubrication*
- 5 x clamping / unclamping (fixture 1)*
- 5 x clamping / unclamping (fixture 2)*

PART SEATED CONTROL

The part seated control is realized by a pneumatic rotary distributor providing four monitoring circuits allowing the individual check of every con rod. Four control lines can be switched any time to every fixture; each two determine which fixture is being checked. The advantage is that with already swiveling A-axis, a check is possible any time, either in the work zone or in the loading position.

CLAMPING SEQUENCE

Clamping sequence and clamping pressure can be freely programmed by NC program.

MINIMUM CHANGE-OVER TIME

The four sided fixture tombstone provides single fixtures for each part type eliminating the requirement of change parts. Thus the effective change-over time is reduced to zero.

CLAMPING FIXTURE

The clamping fixture swiveling around the A-axis linearly moves in Y-direction.



UNCOMPRO- MISINGLY VARIABLE

Up to two turret heads can be placed onto the slide moving in X- and Z-direction. Thus, components can be machined parallel, significantly increasing the total output.

ANY COMBINATION POSSIBLE

Every turret head can receive in all 4, 6 or 8 tools. The choice is between tool clamping systems in three different sizes: HSK 63, HSK 80 and HSK 100. Instead of standard tools, also double spindle heads can be used for bolt hole machining in order to further increase the machine productivity.

NO CHIP-IN-SPINDLE RISK

The tool turret principle prevents the penetration of a chip between spindle and tool.

TURRET BORING HEADS

Two turret boring heads can receive each 4, 6 or 8 tools.

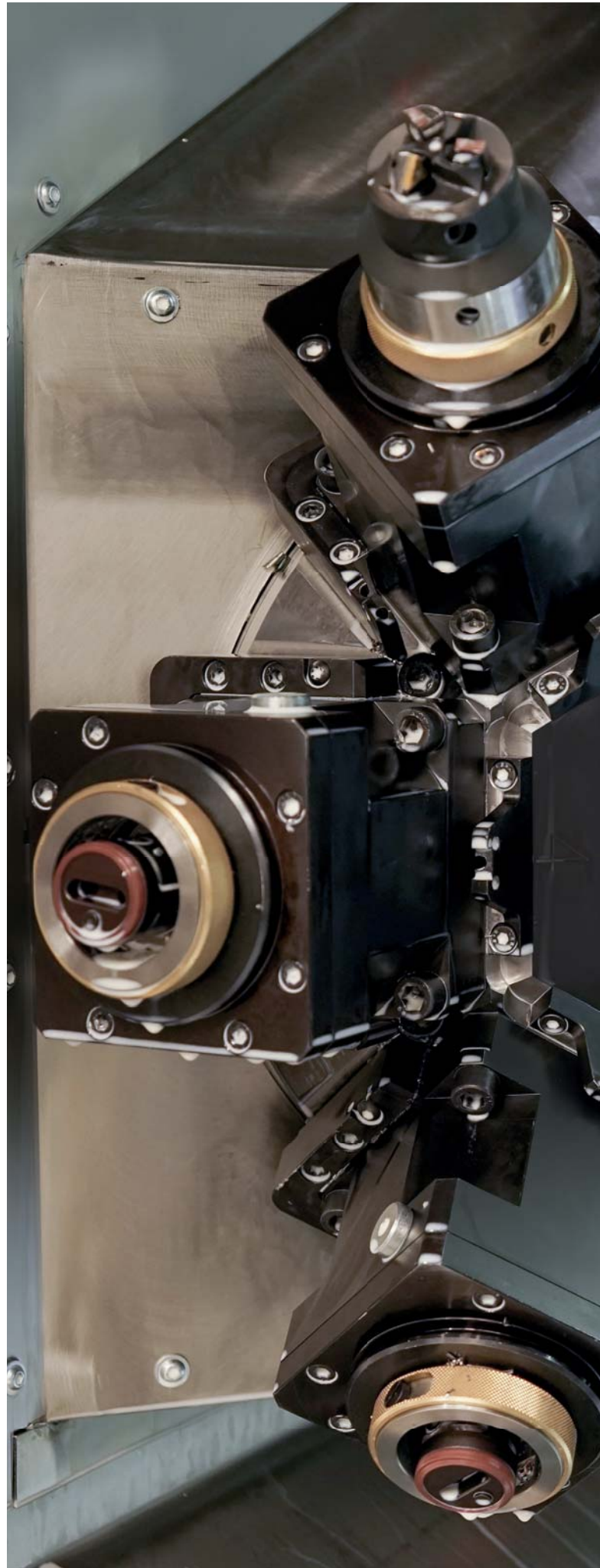

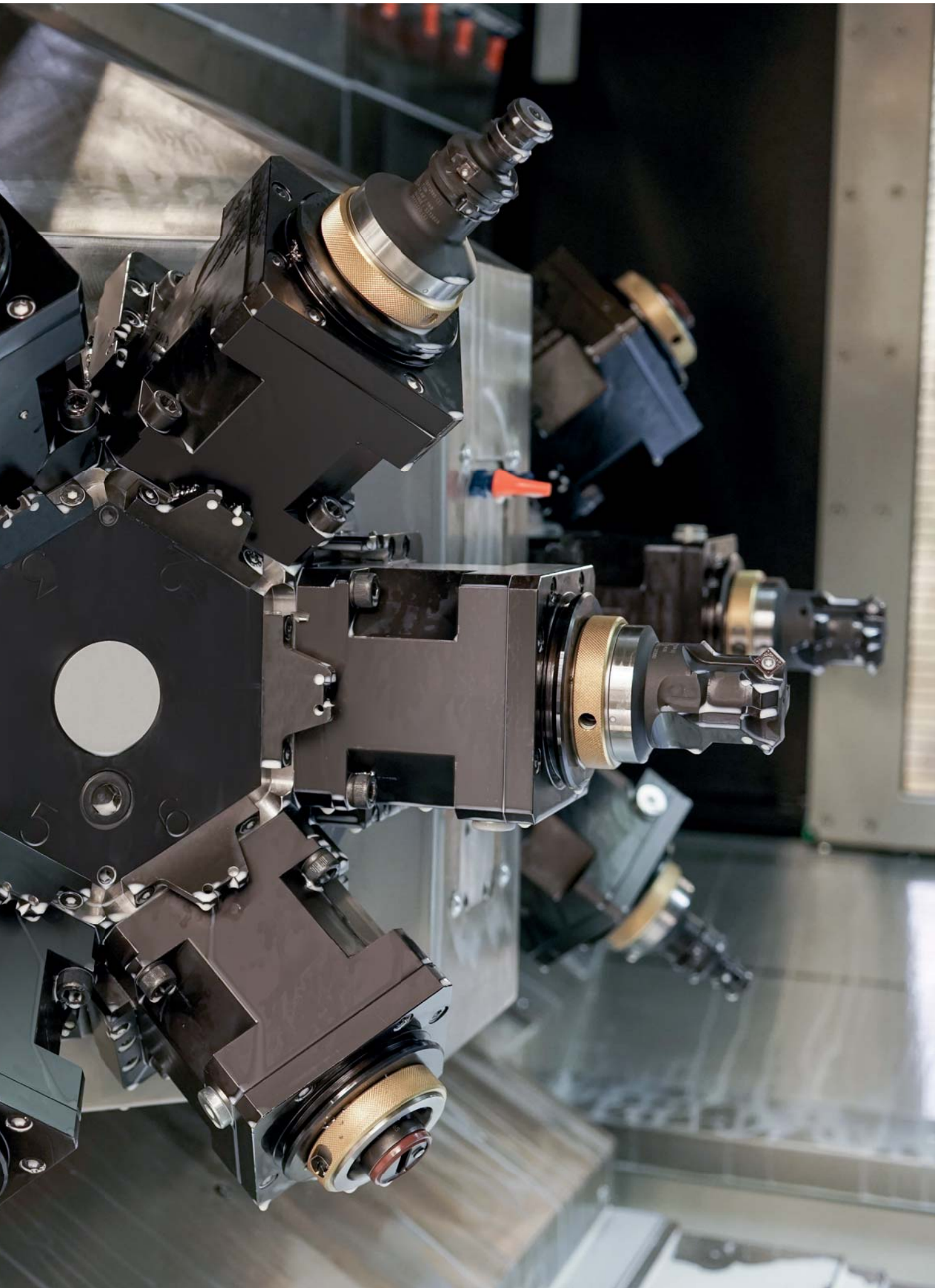



Alfin Corporation
44160 Plymouth Oaks Blvd.
Plymouth, MI 48170
USA
Phone +1 734 414 5884
Fax +1 734 414 5899
ac@alfing-corp.com
www.alfing-corp.com